

# Single Phase PV Inverter Applying a Dual Boost Technology

<sup>1</sup>Smt. Sudha Bhutada, <sup>2</sup>Dr. S.R. Nigam

<sup>1</sup>Electrical Dept.,S.V. polytechnic college, Bhopal (M.P.) ,India

<sup>2</sup>AISECT University,Bhopal (M.P.) ,India

<sup>1</sup>sudha\_bhutada@rediffmail.com, <sup>2</sup>srnigam@gmail.com

**Abstract:** *In this paper, a single-phase PV inverter applying a dual boost converter circuit inverter is proposed for photovoltaic (PV) generation system and PV grid connected system. This system is designed to improve integration of a Single phase inverter with Photovoltaic panel. The DC 24V is converted into to 86V DC and then 86V DC to 312V DC. The 312 V DC is then successfully inverted to AC 220V. Hence solar energy is powerfully converted into electrical energy for fulfilling the necessities of the home load, or to link with the grid. Matlab Simulation software was used for simulation of the circuit and outcome are presented in this paper.*

**Keywords:** H Bridge inverter, dual boost converter, PWM, SPWM

## I. INTRODUCTION

In today's scenario the demand of electricity has increased tremendously. The cause of it is increase in population day by day, economic development of a country and diminution of fossil based fuels. So alternative energy sources i.e. renewable energy sources is the best option without any harm to the nature. [1,2,3] With the advancement in technology in the field of power electronics more than past few years and rising crises for energy have led to increase progress in generating power using renewable energy sources like Photovoltaic (PV), Wind, Fuel cell (FC) based renewable energy technologies. Among all renewable energy sources, solar photovoltaic (PV) electricity generation is the fastest growing source now a day's throughout the world. [4]. In a PV system, a PV array converts solar power to electrical power and a grid connected inverter is required for inverting the electrical power to ac power then it is fed back to the grid. [2]The power electronics device which converts DC power to AC power at required output voltage and frequency level is known as inverter.

At present time almost all instruments whether electrical or electronic require power inverter. The instruments which use ups (uninterruptible power supply) are mostly square or quasi sine wave inverters. They have large harmonics in their output and may damage the devices or electronic instruments. For getting pure sine wave in power electronics sinusoidal pulse width modulation (SPWM) technique is needed. Today this technique is used in inverters to obtain pure sinusoidal wave in the output. The inverters of such technique in the market are very costly and their output is also not true sine wave. So lot of research in this direction is required. A commanding method SPWM is very useful in the area of power electronics such as electrical drives, UPS, renewable energy system and so on. [5]

So for domestic purpose PV inverter is an ideal option. So there is a large scope in this field with a great demand of

electrical energy throughout the world and lot of research is going on to explore this in our day to day life.

In this paper a model of single phase Bridge inverter has been designed using MOSFETS. Gating signals for these MOSFETS have been generated by PWM generator. In order to maintain the conduction time intervals of MOSFETS have been maintained by controlling the pulse width of gating pulses (by varying the reference signals magnitude of the comparator). Input to inverter is given by dual boost converter which is fed by PV panel.

Simulation models (designed in SIMULINK) have been developed and THD is also calculated.

## II. INVERTER

It is a device which converts DC power into AC power at a desired output voltage and frequency is called an Inverter. The input to the inverter is DC which is met either by a battery, fuel cell, PV array, MHD, power supply or from an alternator with rectifier circuit. Impedance of DC source is very less or negligible in case of voltage source inverter and hence input voltage is unvarying. Current source inverter Impedance is very high and can be adjusted. Thus VSI at its input has a stiff DC Voltage source and CSI has a stiff DC current source and their output is constant with variation in load According to semiconductor devices linked inverters are classified as Bridge Inverters, Series Inverters and Parallel Inverters. Bridge Inverters are further classified as half bridge and Full bridge inverters correspondingly. [5,6]

Voltage source inverters with GTOs, power transistors, power MOSFETs or IGBTs, are self commutated. They have controlled turn on and off signals at their gate terminals. Such type of inverters have extensive industrial applications from small switched power supplies to large bulk power transport in field of electrical drives, induction heating, UPS (uninterruptible power supplies) for computers, HVDC transmission lines, etc [5-12].

Power inverters output are either Square Wave, Modified Square Wave (Modified Sine Wave) or Pure Sine Wave (True Sine Wave).

Square wave output is an asymmetrical output. Hence for most of the equipments square wave is not suitable for running them. Hence square wave inverters are not used in the present time.

Modified square wave (modified sine wave) inverters have their output constant, steady and reliable for running the majority of equipments smoothly and efficiently.

Modified sine wave or quasi-sine wave inverters also called the second generation of power inverter. They are an up gradation of square wave inverters. Such inverters are known inverters in reference to their higher cost and lower efficiency as compared to true sine wave inverters. True sine wave inverters are the modern technology inverters. The output waveform of such type of inverter is analogous to utility. These inverters have very less

harmonics and equipments can be operated smoothly. But these inverters are costly.

Pulse width modulation (PWM) is a powerful technique for controlling analog circuits with a processor's digital outputs. It is a very useful technique and has wide applications in measurement and communications areas for power control and conversion. This technique is used to decrease the Total Harmonic Distortion (THD) of load current.

The total harmonic distortion, or THD, is defined as the ratio of the sum of the powers of all harmonic components to the power of the fundamental.

In this technique for controlling the switches of inverter for the sinusoidal PWM output, a reference signal (modulating or control signal) which is usually a sinusoidal wave and a carrier signal which is a triangular wave is needed for controlling the switching frequency. Switching may be unipolar or bipolar type.

At present lot of research in area of multilevel inverters are going on. Such inverters have number of voltage levels more and hence their harmonic content is lesser and output is of improved quality. The design of such inverters is very complex. Multilevel inverters are neutral point clamped, flying capacitor or cascaded H bridge type inverters. Of all Cascaded H bridge type inverter is the best inverter topology.

### III. H BRIDGE INVERTER

An H bridge is an electronic circuit. It enables a voltage to be applied across a load in both directions. The H Bridge is named from its distinctive graphical representation of a circuit. Therefore an H bridge is made using a combination of four solid-state switches. When the switches S1 and S4 are closed (and S2 and S3 are open) a positive voltage will be applied across the load resistor. By opening S1 and S4 switches and closing S2 and S3 switches, the voltage is reversed. The switches S1 and S2 should never be closed at the same time, this condition will short circuit on the input voltage source. For the switches S3 and S4 same condition exists. This condition is recognized as shoot-through. [13]

#### H Bridge Inverter

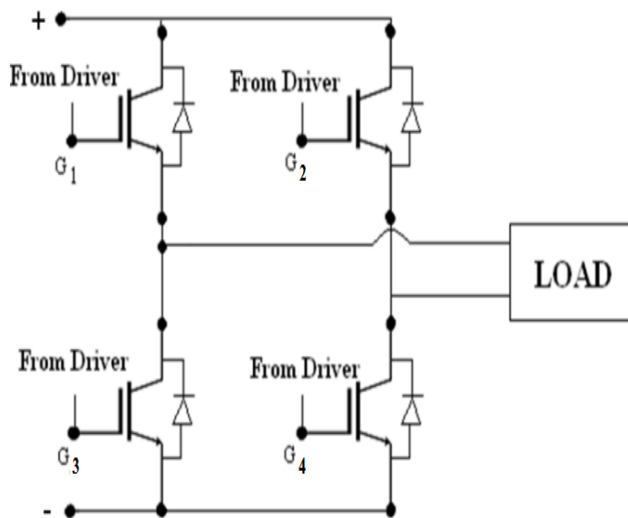

Fig.1

Fig.1 shows the Full H-Bridge Configuration. Single H-Bridge configuration 3 voltage levels are obtained. The number output voltage levels of a cascaded Full H-Bridge are given by  $2n+1$ . The voltage step of each level is given by  $V_{dc}/n$ . In which  $n$  is number of H-bridges connected in cascaded. Usually Sinusoidal pulse width modulation (SPWM) switching techniques are used for solid state switches whose characteristic is they are having constant amplitude pulses with a different duty cycle for each period. to generate this type of signal a sinusoidal with a triangular waveform is compared. [14,15,16].

The switching table is given below-

Switches Turn ON	Voltage Level
S1,S4	$V_{dc}$
S2,S3	$-V_{dc}$

## IV. SIMULATION RESULTS

### 4.1 Simulation of Dual Boost Converter

Dual boost converter designed circuit is as below. [17]

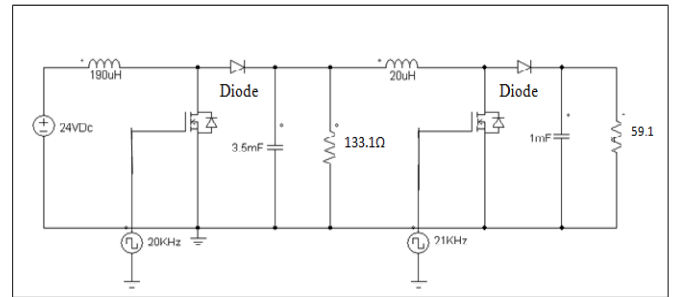

Fig. 2 Dual stage Boost Power Converter

The parameter values taken is as follows-  $V_s=24$  V DC,  $L_1=190e-3$  H,  $L_2=20e-3$  H,  $C_1 = 3.5e-6$  F,  $C_2 = 1e-6$  F,  $R_1 = 133.1$ ohm and load resistance as 59.1 ohm.

Figure 3 shows the simulation of Boost Converter using Matlab /Simulink for PV application

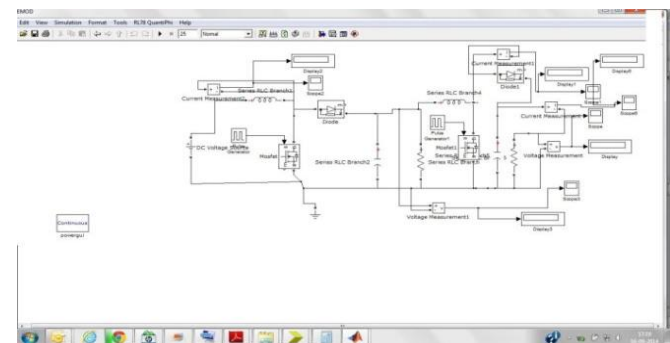

Fig. 3

The circuit consists of the DC voltage source input, two MOSFET switches, 2 inductors, 2 diodes, 2capacitors and load resistances for first stage and second stage respectively. The circuit voltage and current measurement are made with scope to verify the simulation output results and the signal generator is

used to give the pulses to MOSFETs and finally the power GUI is also connected. The DC to DC converter is of boost type. Firstly the first stage converts 24V DC to 86V DC and then 86V DC to 312V DC.[17] . The boost converter output is a regulated fixed output in spite of variations in solar PV system.

### 4.3 SIMULATION RESULTS AND DISCUSSION OF BOOST CONVERTER

A Output waveform of first stage Boost converter

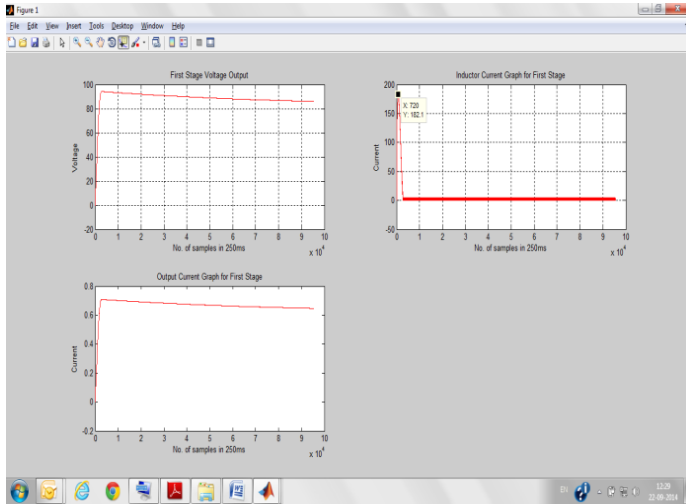

The first stage output obtained was 86 V from 24 V input.

B Output waveform of Second stage (dual stage boost converter)

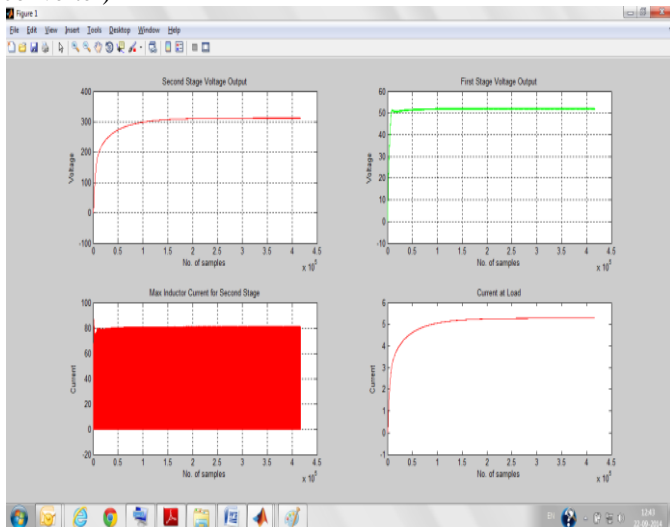

The second stage output obtained was 312 V from 86 V input. In both stage the duty cycle maintained was 0.72. The final load current obtained was 5.289 A.

### 4.4 Simulation of Single phase H bridge inverter for photovoltaic Application using MATLAB/SIMULINK

Simulation circuit of H bridge Inverter using MATLAB/SIMULINK

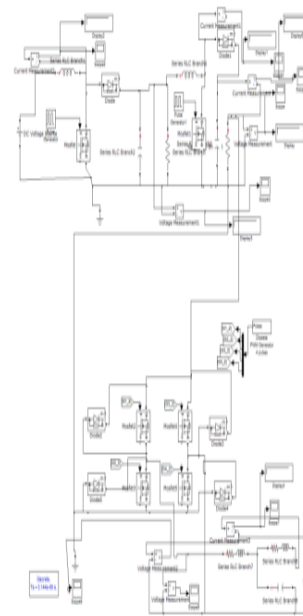

Fig 4

In the H Bridge inverter circuit the input to the inverter was given through boost converter.

The H bridge converter is made with 4 MOSFETs, where the forward voltages of the forced-commutated device and diode are ignored. VSCs are controlled in open loop with the Discrete PWM Generator block available in the Extras/Discrete Control Blocks library. The simulation of Single phase full bridge Inverter using Matlab/simulink, When the S1 and S2 conducts the load voltage is  $V_s$  where as the S3 and S4 conducts the load voltage is  $-V_s$ . Frequency of the output voltage can be controlled by varying the periodic time. The circuit uses the DC voltage ( $V_{dc} = 312$  V), carrier frequency (1080 Hz) and modulation index ( $m = 0.8$ ). The circuit was simulated at the sampling rate of 1/3240 samples per cycle. The sampling time ( $T_s$ ) taken was  $1/50/3240 = 6.17 \times 10^{-6}$  s. The output of inverter was filtered using LCL filter circuit and finally load resistance was inserted in the circuit and output was measured using scope and Power GUI.

The parameter values for inverter and LCL filter circuit taken are as below -

- $V_{dc} = 312$  V
- Pulse generator:
- Amplitude = 1v
- Sample time =  $6.17 \times 10^{-6}$ s
- Pulse width(% of period) = 80%
- Phase delay(secs)=0
- R load =50ohms
- $L_1 = 55$ mH,  $L_2 = 55$ mH
- $C = 159$  $\mu$ F

The Inverter Output Voltage = 332.2V and Output Current = 6.663A and THD of output voltage and load current was found to be 0.15%.

#### Simulation results

H Bridge Inverter Output Voltage and Current Waveforms

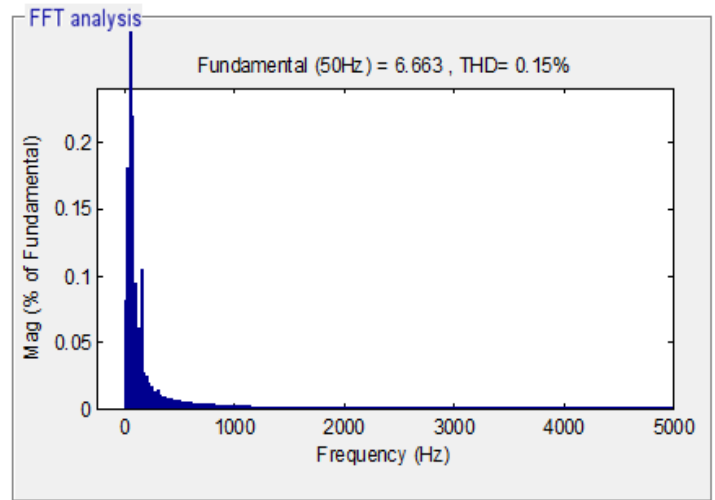
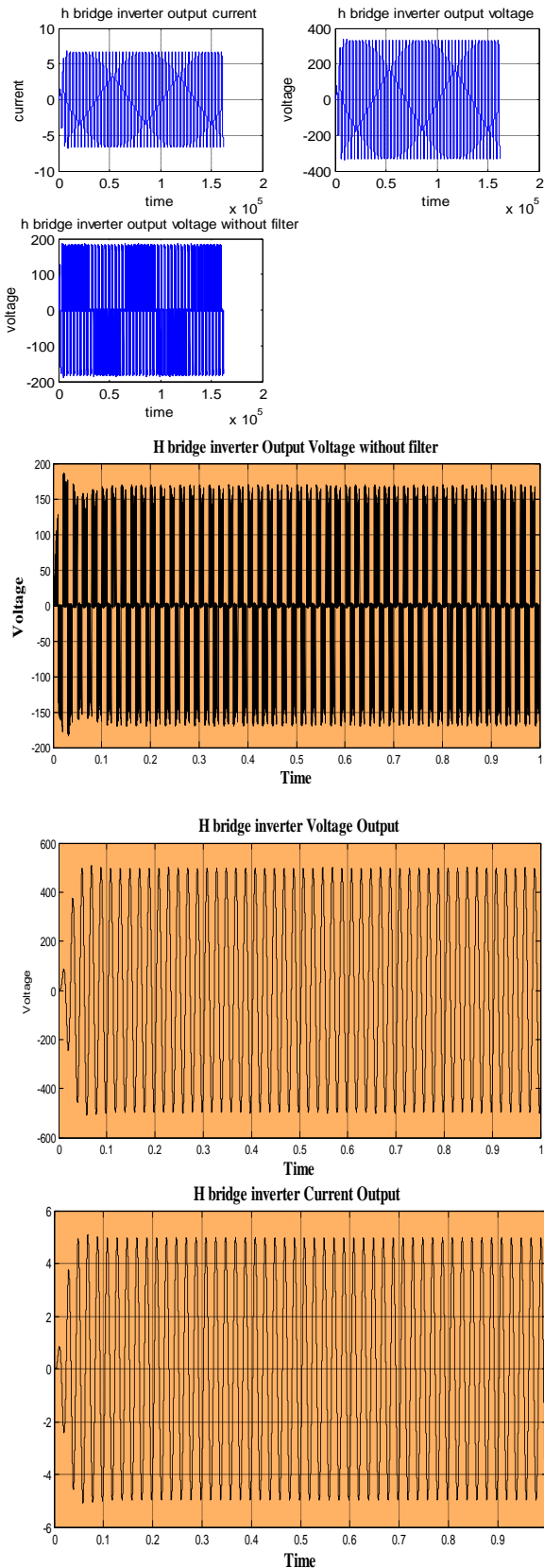

### EFFICIENCY TABLE CALCULATION FOR DIFFERENT LOADS

Load	Output Current	Power Output	Power Input	THD	Efficiency
5Ω	10.12A	286.4W	287W	.178%	99.7%
10Ω	9.853A	490.2W	492.1W	.18%	99.9%
20Ω	8.802A	776.1W	776.9W	.14%	99.8%
30Ω	7.952A	951.3W	952.2	.10%	99.9%
40Ω	7.25A	1054W	1052W	.14%	99.8%
50Ω	6.705A	1122W	1123.4W	.17%	99.87%
70Ω	5.89A	1201W	1202W	.30%	99.9%
90Ω	5.295A	1235W	1237W	.56%	99.83%
100Ω	5.048A	1243W	1245W	.71%	99.8%

### V CONCLUSION

In this paper the single phase H Bridge Inverter 1500VA, using dual boost concept and SPWM technique for triggering MOSFET was designed and tested for fixed modulation index of 0.8. The Inverter was tested for different resistive loads. It was found that the efficiency of inverter is near around 99.8%. These results were tested in MATLAB/SIMULINK. In order to achieve a much better performance, improvements like change in modulation index and filter circuit design can be made.

### REFERENCES

- i. D Chauhan, S Agarwal, Suman M.K, "Policies For Development Of Photovoltaic Technology:A Review" *International Journal of software & hardware research in engineering*, Vol. 1, pp. 52-57, December 2013.
- ii. M. R. Islam, Y. G. Guo, and J. G. Zhu, "11-kV series-connected Hbridge multilevel converter for direct grid connection of renewable energy systems," *Journal of Int. Conf. Elec. Mach. Systems*, vol. 1, no.2, pp. 211-219, June 2012.
- iii. H. Patel and V. Agarwal, "A Single-Stage Single-Phase TransformerLess Doubly Grounded Grid-Connected PV Interface," *Energy Conversion, IEEE Transactions on*, vol. 24, pp. 93-101, 2009.

### FFT Analysis of Load Current



- iv. Minjie Chen, Xutao Lee and Yoshihara Tsutomu, "A Novel Soft-Switching Grid-Connected PV Inverter and its Implementation", *IEEE PEDS 2011, Singapore*, 5 - 8 December 2011
- v. Owen, E.L., "History [origin of the inverter]," *Industry Applications Magazine, IEEE*, vol.2, no.1, pp.64-66, Jan/Feb 1996
- vi. B. Ismail, s.taib mieee, a. R mohd saad, m. Isa, C. M. Hadzer, "Development Of A Single Phase Spwm Microcontroller-Based Inverter" *First International Power And Energy Conference Pecon 2006 November 28-29, 2006, Putrajaya, and Malasia .PN.437-440.*
- vii. Maria D. Bellar, Tzong-Shiann Wu, Aristide Tchamdjau, Javad Mahdavi and M. Ehsani, "A Review of Soft-switched DC-AC Converter," *IEEE trans. On Industry Appl*, vol. 43, no. 4, pp 847-858, 1998.
- viii. Edelmoser, K.H., Himmelstoss, F.A., "Improved 1kW solar inverter with wide input voltage range," *Signals, Circuits and Systems*, 2003. SCS 2003. *International Symposium on*, vol.1, pp. 201- 204 vol.1, 10-11 July 2003
- ix. Chien-Ming Wang, "A novel single-stage full-bridge buck-boost inverter," *Applied Power Electronics Conference and Exposition*, 2003. APEC '03. *Eighteenth Annual IEEE*, vol.1, no., pp. 51- 57 vol.1, 9-13 Feb. 2003
- x. Baharuddin Bin Ismail, "Design And Development Of Unipolar Spwm Switching Pulses For Single Phase full bridge Inverter application", *MS Uni-versity Sains Malaysia*, 2008
- xi. L. Bowtell and T. Ahfock are with Faculty of Engineering Survey-ing, University of Southern Queensland, Australia (bowtell@usq.edu.au), "Compari- son Between Unipolar and Bipolar Sigle Phase Grid connected Inverters for PV Applications" September 20, 2007.
- xii. B. Ismail, S. T. (November 28-29, 2006), "Development of a Single Phase SPWM Microcontroler -Based Inverter", *First International Power and Energy Conference PEC* (p. 437). *Putrajaya, Malaysia: IEEE*
- xiii. Ankur Namdeo , Manoj Sharma , Abhishek Dixit, "Digital Control of Single Phase H Bridge Converter Using Matlab/Dspace", *International Journal of Engineering Research & Technology (IJERT)*, Vol. 3 Issue 8, August – 2014.
- xiv. S.M Islam, G.M sharif, "microcontroller based sinusoidal PWM inverter for photovoltaic application" *First International Conference development in renewable energy technology*, p 1-4, December 2009, IEEE.
- xv. P Zope, P Bhangale, P Sonare, S Suralkar, "design and implementation of carrier based sinusoidal PWM inverter" *International Journal of advanced research in electrical, electronics and instrumentation engineering*, Vol 1, pp. 230-236, October 2012.

xvi. R Senthilkumar, M Singaaravelu, " design of single phase inverter using dsPIC30F4013" *International Journal Engineering Research & Technology (IJERT)*, Vol 2, pp. 6500-6506, 2012.

xvii. Sudha Bhutada, S R Nigam, " Design & Simulation Of Boost Conveter For Solar Application" , *CiiT International Journal of Programmable Device Circuits and Systems*, Vol 7, No01, January 2015.



Sudha Bhutada received the B.E. (Hons) Electrical from MACT Bhopal in 1990 and M.Tech H.E.E from MANIT Bhopal in 2002.

Since 1997, she has been working as a Lecturer at S V Polytechnic Bhopal. Since 2013 she has been a research scholar in AISECT University.



Dr. (Prof.) S.R. Nigam  
Professor of Electrical Engineering  
Area of Specialisation: Power Electronic  
Presently working on Renewable Energy, Solar Heat and Wind Power Plant. Has 40 years of experience in teaching and research in various capacities in four different universities of India.